



TO-251-3L Plastic-Encapsulate Transistors

2SD1815 TRANSISTOR (NPN)

FEATURES

- Low Collector-to-Emitter Saturation Voltage
- Excellent Linearity of h_{FE}
- High f_T
- Fast Switching Time

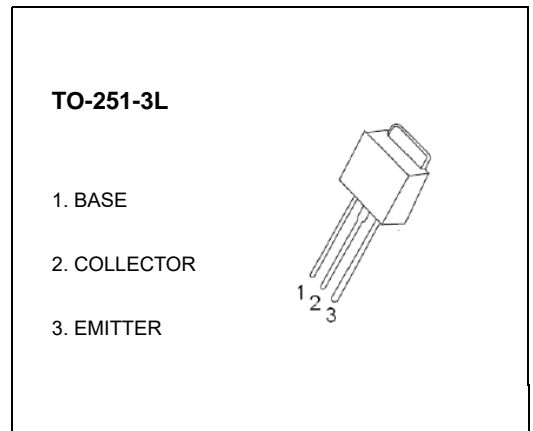

MARKING

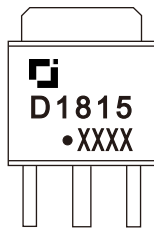

D1815=Device code
 Solid dot=Green moldinn compound device,
 if none,the normal device
 XXXX=Code

Equivalent Circuit

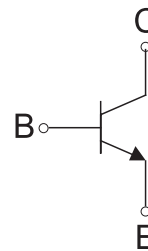

MAXIMUM RATINGS ($T_a=25^{\circ}C$ unless otherwise note)

Symbol	Parameter	Value	Unit
V_{CBO}	Collector-Base Voltage	120	V
V_{CEO}	Collector-Emitter Voltage	100	V
V_{EBO}	Emitter-Base Voltage	6	V
I_C	Collector Current -Continuous	3	A
P_C	Collector Power Dissipation	1	W
T_J, T_{stg}	Operation Junction and Storage Temperature Range	-55 to +150	$^{\circ}C$

ELECTRICAL CHARACTERISTICS (Ta=25°C unless otherwise specified)

Parameter	Symbol	Test conditions	Min	Typ	M	
Collector-base breakdown voltage	$V_{(BR)CBO}$	$I_C=10\mu A, I_E=0$	120			V
Collector-emitter breakdown voltage	$V_{(BR)CEO}$	$I_C=1mA, I_B=0$	100			V
Emitter-base breakdown voltage	$V_{(BR)EBO}$	$I_E=10\mu A, I_C=0$	6			V
Collector cut-off current	I_{CBO}	$V_{CB}=100V, I_E=0$			1	μA
Emitter cut-off current	I_{EBO}	$V_{EB}=4V, I_C=0$			1	μA
DC current gain	$h_{FE(1)}$	$V_{CE}=5V, I_C=500mA$	70		400	
	$h_{FE(2)}$	$V_{CE}=5V, I_C=2A$	40			
Collector-emitter saturation voltage	$V_{CE(sat)}$	$I_C=1.5A, I_B=150mA$			0.4	V
Base -emitter saturation voltage	$V_{BE(sat)}$	$I_C=1.5A, I_B=150mA$			1.2	V
Transition frequency	f_T	$V_{CE}=10V, I_C=500mA$		180		MHz
Collector output capacitance	C_{ob}	$V_{CB}=10V, I_E=0, f=1MHz$		25		pF
Turn-on time	t_{on}	$V_{CC}=50V, I_C=1.5A, I_{B1}=-I_{B2}=-0.15A$		100		ns
Storage time	t_S			900		ns
Fall time	t_f			50		ns

CLASSIFICATION OF $h_{FE(1)}$

Rank	Q	R	S	T
Range	70-140	100-200	140-280	200-400

Typical Characteristics

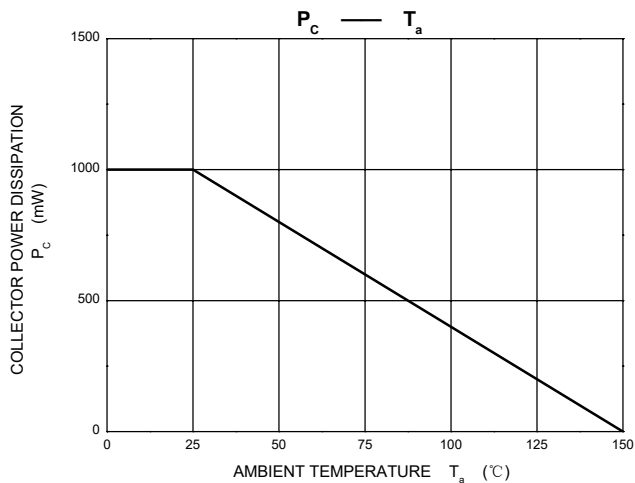
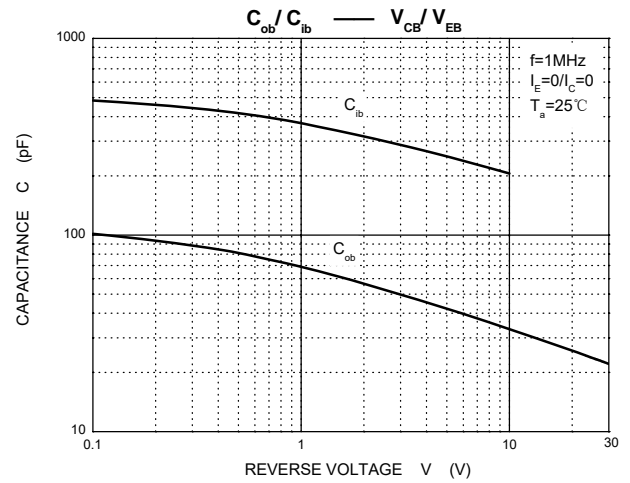
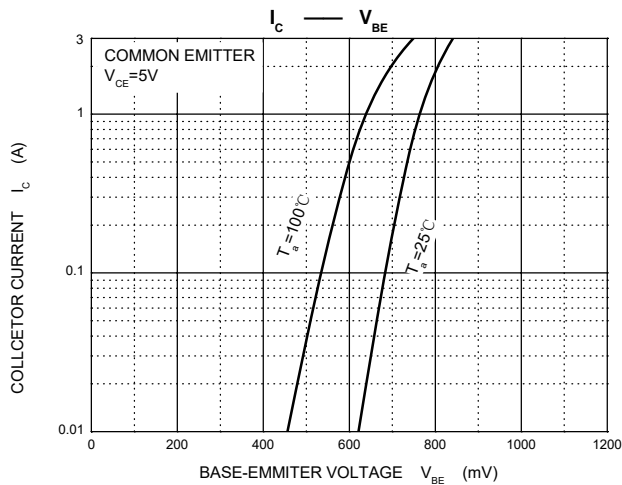
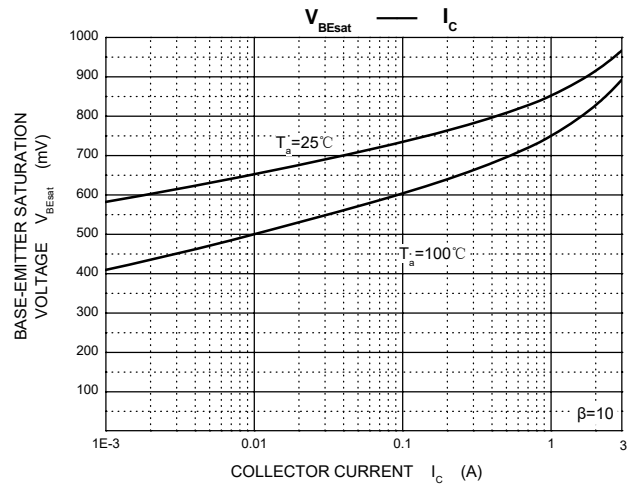
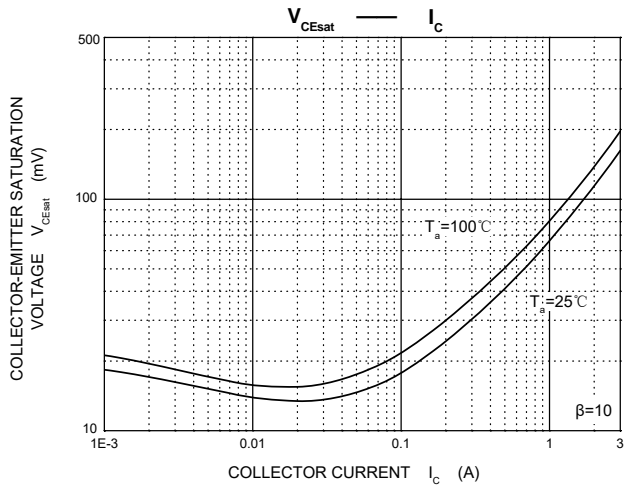
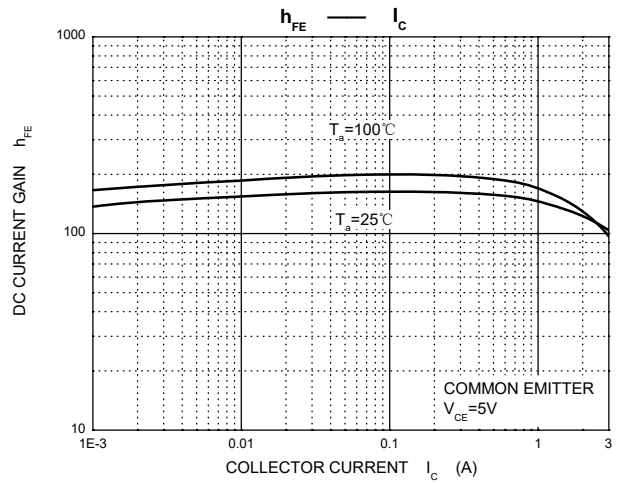
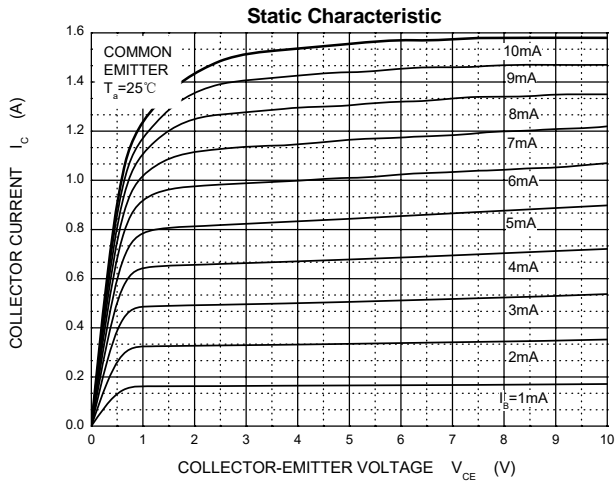

TO-251-3L Package Outline Dimensions

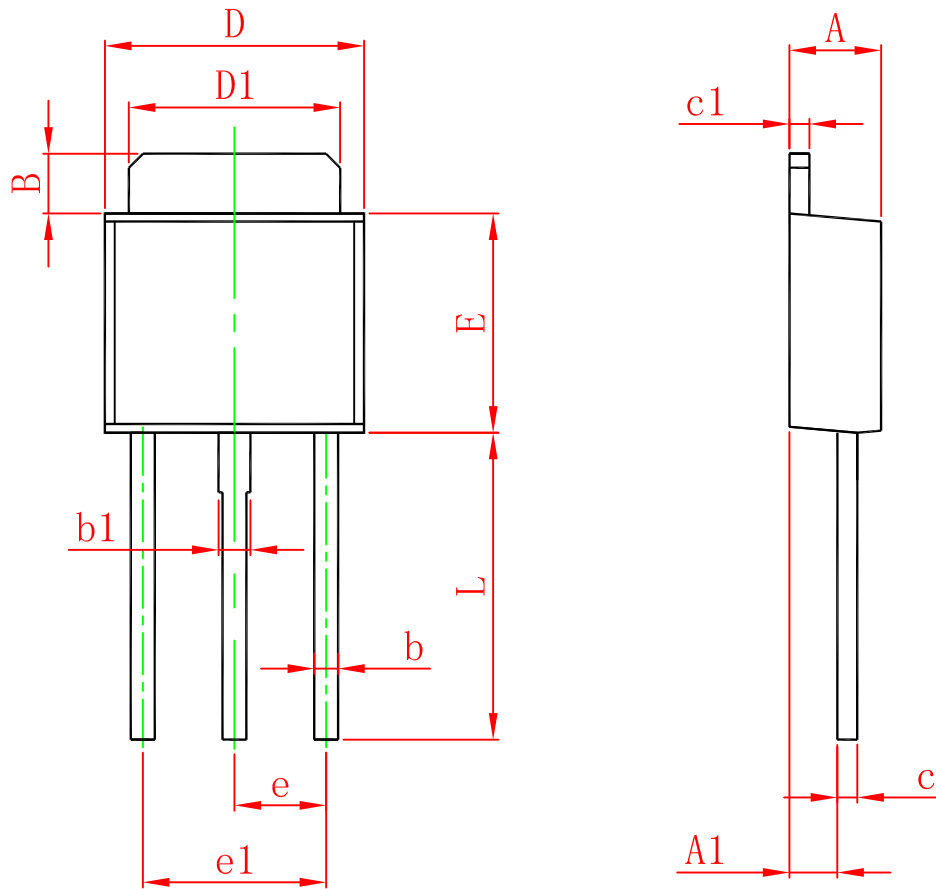

Symbol	Dimensions In Millimeters		Dimensions In Inches	
	Min.	Max.	Min.	Max.
A	2.200	2.400	0.087	0.094
A1	1.050	1.350	0.042	0.054
B	1.350	1.650	0.053	0.065
b	0.500	0.700	0.020	0.028
b1	0.700	0.900	0.028	0.035
c	0.430	0.580	0.017	0.023
c1	0.430	0.580	0.017	0.023
D	6.350	6.650	0.250	0.262
D1	5.200	5.400	0.205	0.213
E	5.400	5.700	0.213	0.224
e	2.300 TYP.		0.091 TYP.	
e1	4.500	4.700	0.177	0.185
L	7.500	7.900	0.295	0.311